

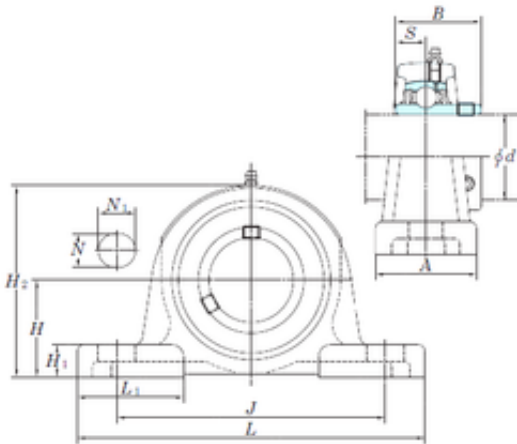

## China 608 Bearing Supplier



UCP201 Bearing 2D drawings and 3D CAD models

SKF Snr NTN NSK Koyo Timken Pillow Block  
Bearing UCP201 UCP202 UCP203 UCP204  
UCP205 UCP206 UCP207 UCP208 UCP209  
UCP210

Bearing No. UCP201

Bore Diameter	12 mm
Width	31 mm
d	12 mm
A	38 mm
B	31 mm
H	30,2 mm
H1	12 mm
H2	60 mm
J	95 mm
L	127 mm
L1	38 mm
N	13 mm
N1	18 mm
S	12,7 mm
Bolt (G)	M10
Weight	0,63 Kg
Basic dynamic load rating (C)	12,8 kN
Basic static load rating (C0)	6,65 kN
Bearing No.	UCP201
Bolt size	M10
Cr	12.8
C0r	6.65
f0	13.2



## China 608 Bearing Supplier

(Refer.)Unit mass(kg)	0.63
Nipple size	1/4-28UNF